



MSW3T-310X-150

SP3T Surface Mount High Power PIN Diode Switch

Features:

- | | |
|--|---------------------|
| • Surface Mount SP3T Switch: | 9mm x 6mm x 2.5mm |
| • Industry Leading Average Power Handling: | +50 dBm (CW) |
| • High RF Peak Power: | +53 dBm (Peak) |
| • Low Insertion Loss: | < 0.4 dB |
| • High IP3: | >65dBm |
| • Operates from Positive Voltages Only: | +5V & +28V to +125V |
| • RoHS Compliant | |

Description:

The MSW3T-310X-150 series of surface mount High Power PIN Diode switches leverage high reliability hybrid manufacturing processes which yield proven superior performance to both MMIC and Glass Carrier based technologies. The hybrid design approach permits precise PIN Diode selection to optimize RF performance while maintaining competitive cost targets. The small form factor (9mm x 6mm x 2.5mm) offers world class power handling, low insertion loss, and superior intermodulation performance exceeding all competitive technologies.

Typical Applications:

- Radar T/R Modules
- Switch Bank Filters
- Mil-Com Radios

The MSW3T-310X-150 series of High Power SP3T switches are intended for use in high power, high reliability, mission critical applications across the HF to 4 GHz frequency ranges. The manufacturing process has been proven through years of extensive use in high reliability applications.

The MSW3T-310X-150 family of SP3T switches are fully RoHS compliant.

ESD and Moisture Sensitivity Level Rating:

The MSW3T-310X-150 carries an ESD ratings of Class 1C, Human Body Model (HBM) and a moisture sensitivity rating of MSL 1.

MSW3T-3100-150 Specifications @ $Z_o = 50\Omega$; $T_a = +25^\circ\text{C}$

Parameter	Symbol	Units	Test Conditions	Min Value	Typical Value	Max Value
Frequency	F	MHz		20		1,500
J0-J1, J0-J2 or J0-J3 Insertion Loss (Note 1)	IL	dB	-180V @ -50mA (ON) +1V @ +50 mA (OFF)		0.4	0.6
J0-J1, J0-J2 or J0-J3 Return Loss (Note 1)	RL	dB	-180V @ -50mA (ON) +1V @ +50 mA (OFF)	18	20	
J0-J1, J0-J2 or J0-J3 Isolation (Note 1)	ISO	dB	-180V @ -50mA (ON) +1V @ +50 mA (OFF)	44	47	
CW Incident Power (Note 1)	$P_{inc}(CW)$	dBm	-180V @ -50mA (ON) +1V @ +50 mA (OFF) 3.0:1 Source & Load VSWR		50	
Peak Incident Power (Note 1)	$P_{inc}(Pk)$	dBm	-180V @ -50mA (ON) +1V @ +50 mA (OFF) 1.5:1 Source & Load VSWR		53 @ 10 uS Pulse, 1% Duty	
Switching Speed	T_s	us	(10%-90%) RF Voltage TTL rep rate = 100 kHz		2	3
Input 3 rd Order Intercept Point	IIP3	dBm	F1 = 500 MHz F2 = 510 MHz P1 = P2 = +40 dBm -180V @ -50 mA (ON) +1V @ +50 mA (OFF)	60	65	

MSW3T-3101-150 Specifications @ $Z_o = 50\Omega$; $T_a = +25^\circ\text{C}$

Parameter	Symbol	Units	Test Conditions	Min Value	Typical Value	Max Value
Frequency	F	MHz		200		4,500
J0-J1, J0-J2 or J0-J3 Insertion Loss (Note 1)	IL	dB	-180V @ -50mA (ON) +1V @ +50 mA (OFF)		0.6	0.8
J0-J1, J0-J2 or J0-J3 Return Loss (Note 1)	RL	dB	-180V @ -50mA (ON) +1V @ +50 mA (OFF)	13	15	
J0-J1, J0-J2 or J0-J3 Isolation (Note 1)	ISO	dB	-180V @ -50mA (ON) +1V @ +50 mA (OFF)	32	35	
CW Incident Power (Note 1)	$P_{inc}(CW)$	dBm	-180V @ -50mA (ON) +1V @ +50 mA (OFF) 1.5:1 Source & Load VSWR		50	
Peak Incident Power (Note 1)	$P_{inc}(Pk)$	dBm	-180V @ -50mA (ON) +1V @ +50 mA (OFF) 1.5:1 Source & Load VSWR		53 @ 10 uS Pulse, 1% Duty	
Switching Speed	T_s	us	(10%-90%) RF Voltage TTL rep rate = 100 kHz		1	2
Input 3 rd Order Intercept Point	IIP3	dBm	F1 = 2,000 MHz F2 = 2,010 MHz P1 = P2 = +40 dBm -180V @ -50 mA (ON) +1V @ +50 mA (OFF)	60	65	

MSW3T-310X-150 SP3T Schematic

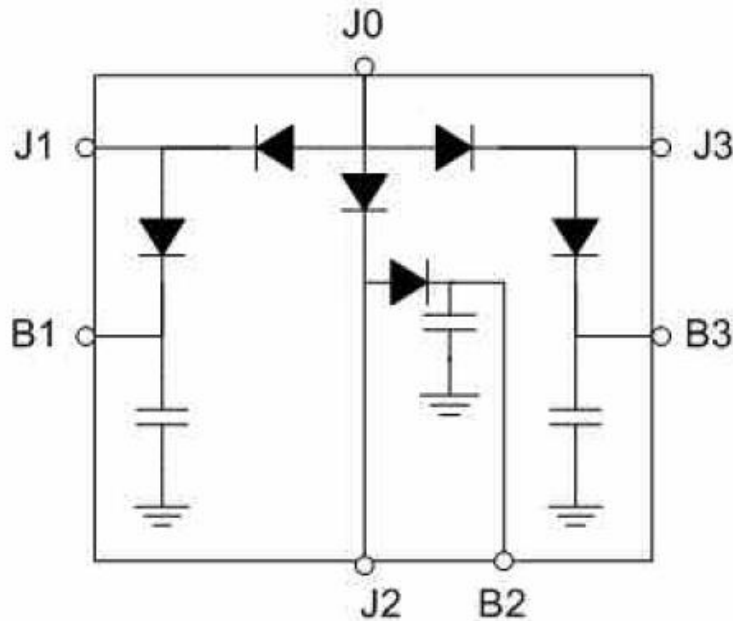

RF Truth Table

RF State	J1 Bias	B1 Bias	J2 Bias	B2 Bias	J3 Bias	B3 Bias
J1-J0 "ON" J2-J0 "OFF" J3-J0 "OFF"	0V @ -100 mA	27V @ 0mA	27V @ 0mA	0V @ -25mA	27V @ 0mA	0V @ -25mA
J1-J0 "OFF" J2-J0 "ON" J3-J0 "OFF"	27V @ 0mA	0V @ -25mA	0V @ -100 mA	27V @ 0mA	27V @ 0mA	0V @ -25mA
J1-J0 "OFF" J2-J0 "OFF" J3-J0 "ON"	27V @ 0mA	0V @ -25mA	27V @ 0mA	0V @ -25mA	0V @ -100 mA	27V @ 0mA

Minimum Reverse Bias Voltage @ J1, J2, J3 vs. Frequency @ 100W (CW) VSWR: 1.5:1

Part Number	Frequency & Min Bias Voltage	Frequency & Min Bias Voltage	Frequency & Min Bias Voltage	Frequency & Min Bias Voltage	Frequency & Min Bias Voltage	Frequency & Min Bias Voltage
	20 MHz	100 MHz	200 MHz	400 MHz	1 GHz	4 GHz
MSW3T-3100-150	-180V	-150V	-115V	-85V	-35V	N/A
MSW3T-3101-150	N/A	N/A	-150V	-115V	-55V	-35V

MSW3T-310X-150 Absolute Maximum Ratings @ $T_A = +25\text{ }^\circ\text{C}$ (unless otherwise denoted)

Parameter	Absolute Maximum Value
Forward Current @ J1, J2 or J3	250 mA
Forward Current @ B1, B2 or B3	150 mA
Reverse Voltage @ J1, J2 or J3	125 V
Reverse Voltage @ B1, B2 or B3	125 V
Forward Diode Voltage	1.2 V @ 250 mA
Operating Temperature	-65 °C to +125 °C
Storage Temperature	-65 °C to +150°C
Junction Temperature	+175 °C
Assembly Temperature	+260 °C for 10 seconds
CW Incident Power Handling - J0, J1, J2, J3 Source & Load VSWR = 1.5 : 1 (Cold and Hot Switching) See Notes below: 1 & 2	+50 dBm @ +85 °C Case Temp
Peak Incident Power Handling - J0, J1, J2, J3 Source & Load VSWR = 1.5 : 1 (Cold and Hot Switching) See Notes below: 1 & 2	+55 dBm @ 10 usec pulse, 1% duty cycle @ +85 °C Case Temp
Total Dissipated RF & DC Power (Cold Switching) See Notes below: 1 & 2	12 W @ +85 °C Case Temp

Notes:

- 1) For Hot Switching, PIN Diode Drivers must transition between states in less than 100 nsec with a parallel RC spiking network at the Driver Output.
- 2) Backside RF and DC grounding area of the MSW3T-310X-150 must be completely solder attached to the RF Circuit board for proper electrical and thermal circuit grounding.

MSW3T-3100-150 Small Signal Parametric Performance:

MSW3T-3100-150 Insertion Loss vs. Frequency

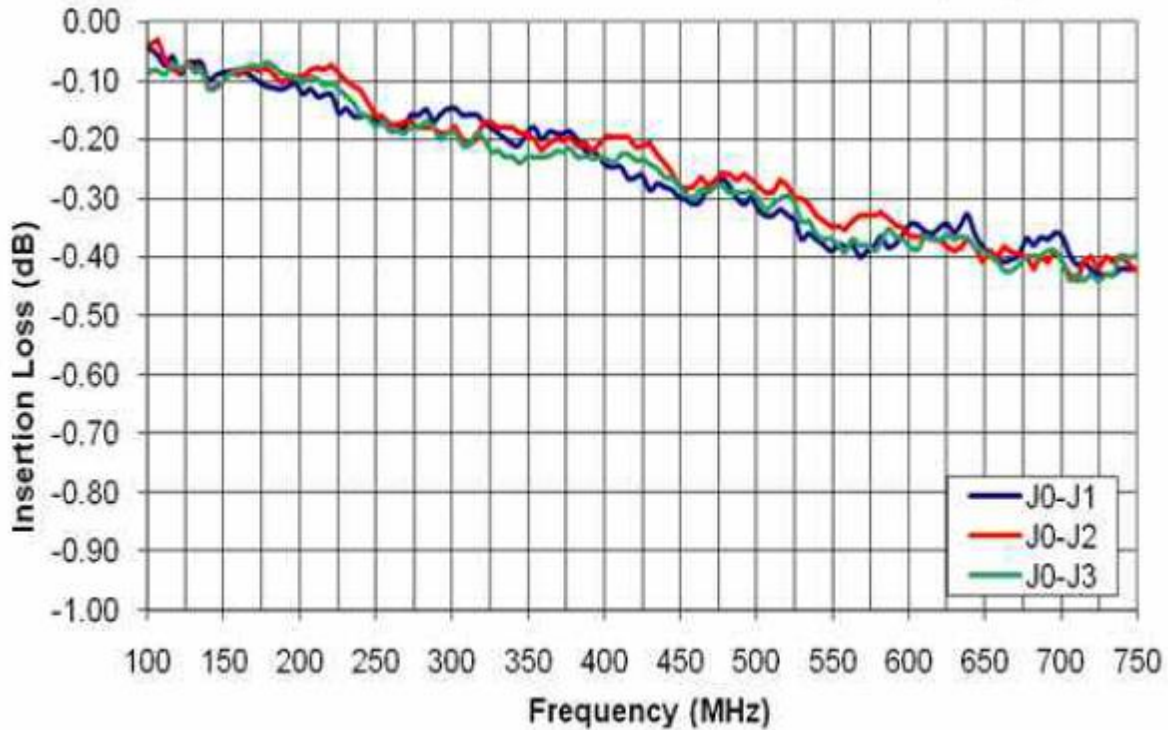

MSW3T-

3100-150 Return Loss vs. Frequency

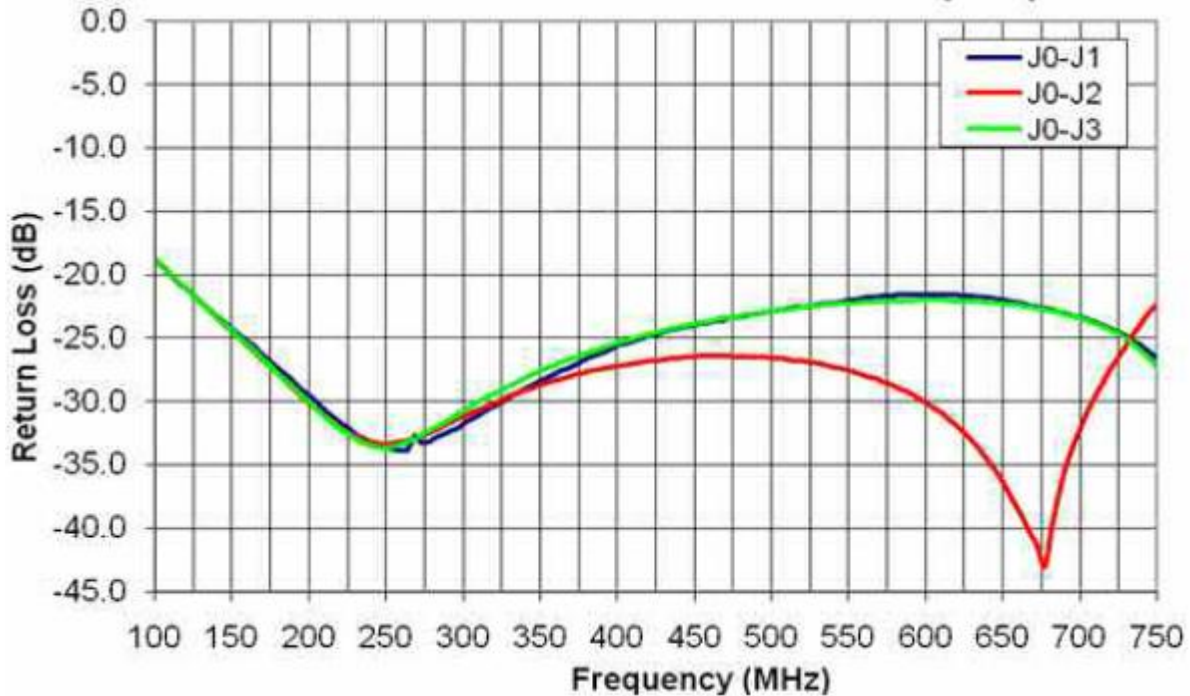

MSW3T-3100-150 Isolation vs. Frequency

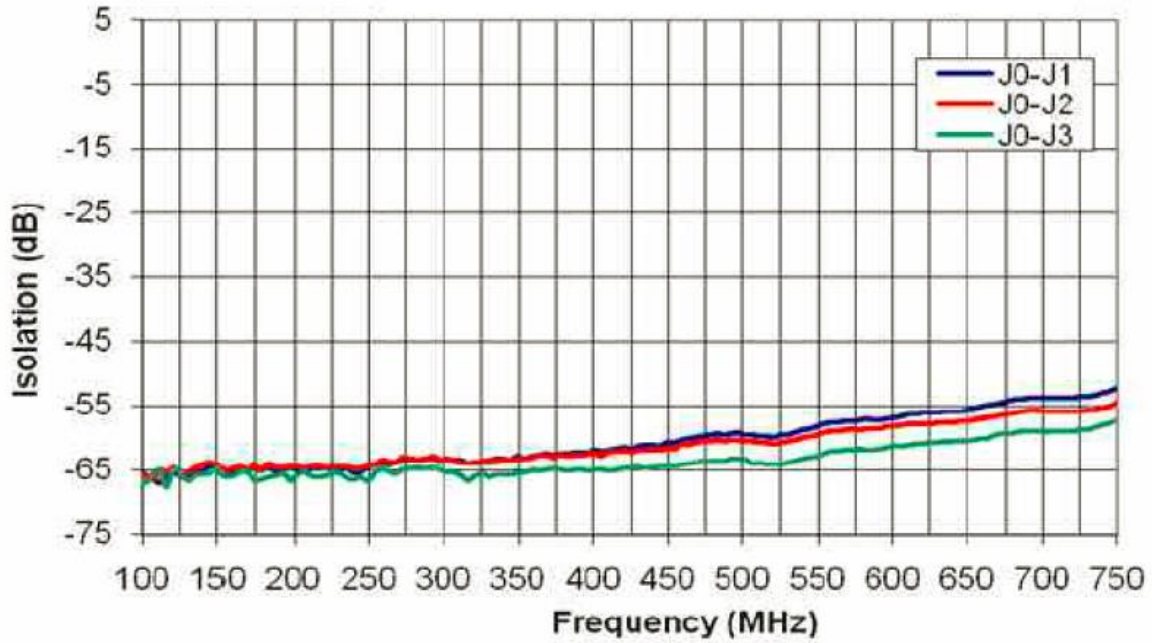

MSW3T-3101-150 Small Signal Parametric Performance:

MSW3T-3101-150 Insertion Loss vs. Frequency

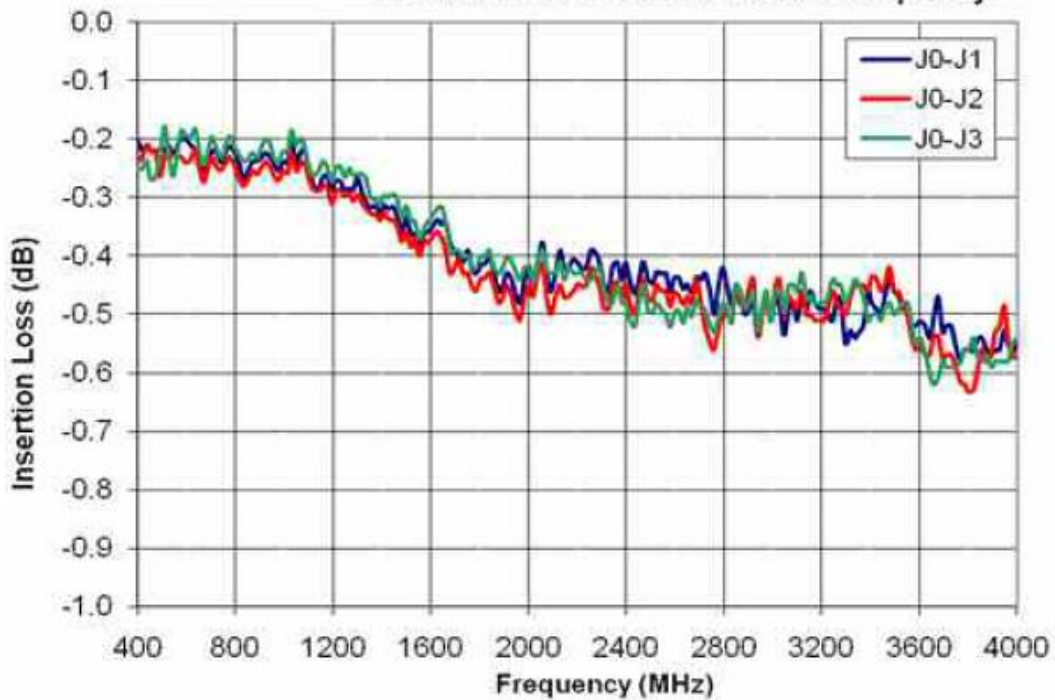

MSW3T-3101-150 Return Loss vs. Frequency

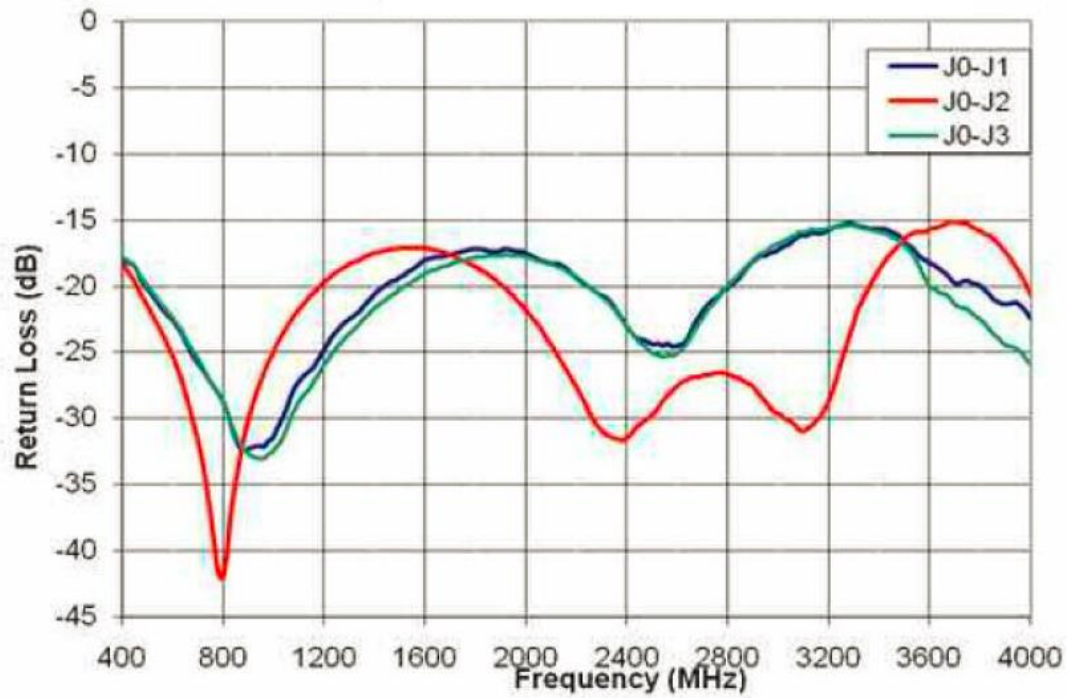

MSW3T-3101-150 Isolation vs. Frequency

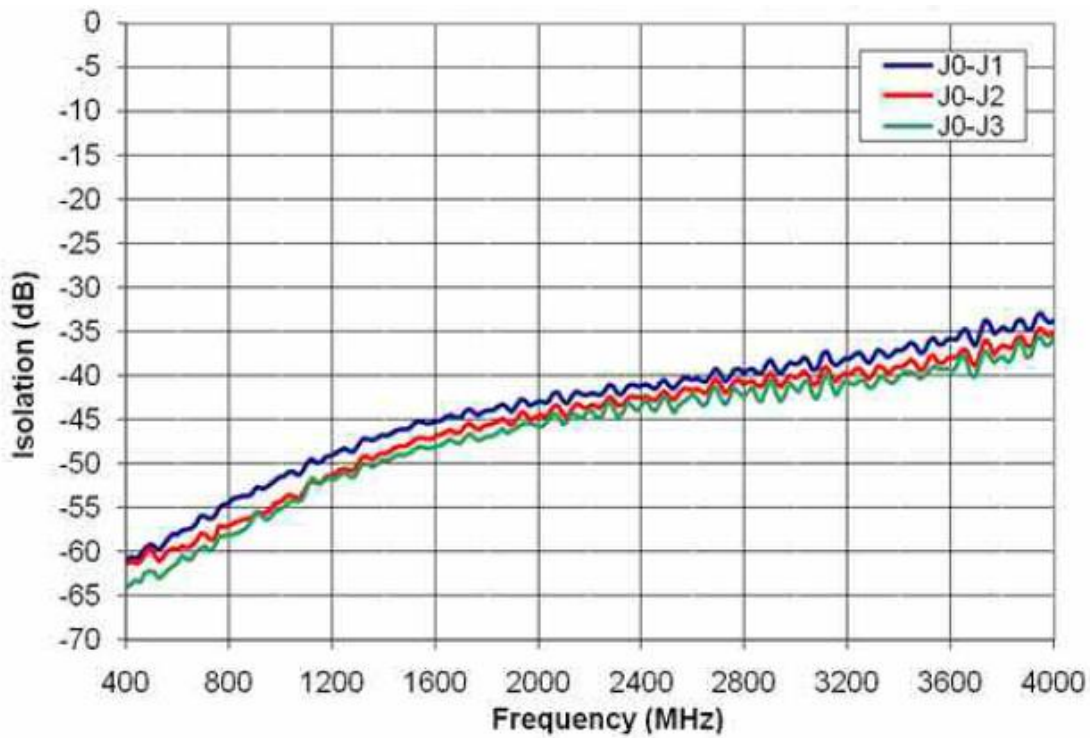

Assembly Instructions

The MSW3T-310X-150 family of High Power Switches are available in either tube or Tape & Reel format. The MSW3T-310X-150 may be attached to the printed circuit card using solder reflow procedures using either RoHS or Sn63/ Pb37 type solders per the Table and Temperature Profile Graph shown below:

Profile Parameter	Sn-Pb Assembly Technique	RoHS Assembly Technique
Average ramp-up rate (T_L to T_P)	3°C/sec (max)	3°C/sec (max)
Preheat		
Temp Min (T_{smin})	100°C	100°C
Temp Max (T_{smax})	150°C	150°C
Time (min to max) (t_s)	60 – 120 sec	60 – 120 sec
T_{smax} to T_L		
Ramp up Rate		3°C/sec (max)
Peak Temp (T_P)	225°C +0°C / -5°C	245°C +0°C / -5°C
Time within 5°C of Actual Peak Temp (T_P)	10 to 30 sec	20 to 40 sec
Time Maintained Above:		
Temp (T_L)	183°C	217°C
Time (t_L)	60 to 150 sec	60 to 150 sec
Ramp Down Rate	6°C/sec (max)	6°C/sec (max)
Time 25°C to T_P	6 minutes (max)	8 minutes (max)

Solder Re-Flow Time-Temperature Profile

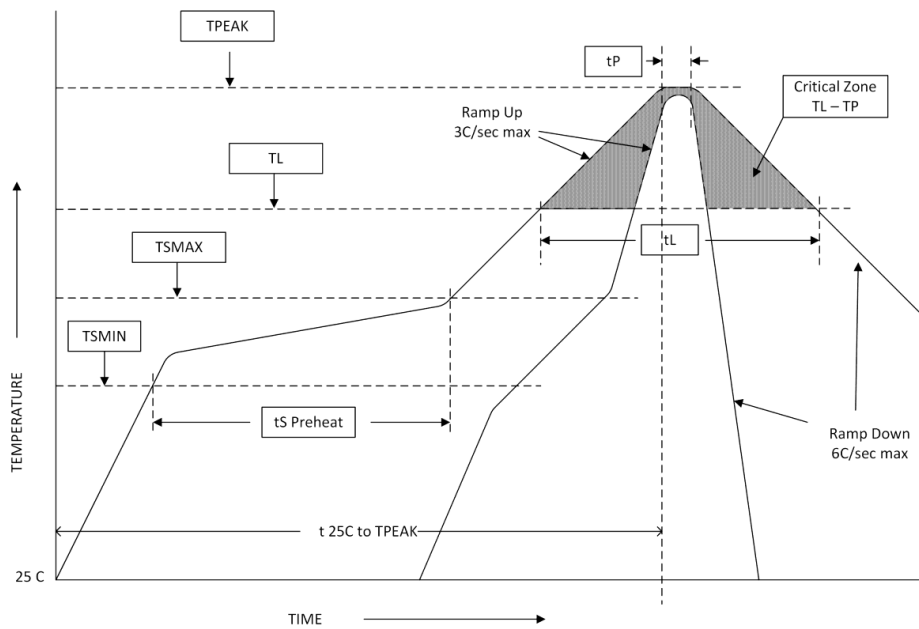

MSW3T-310X-150 SP3T Package Outline Drawing

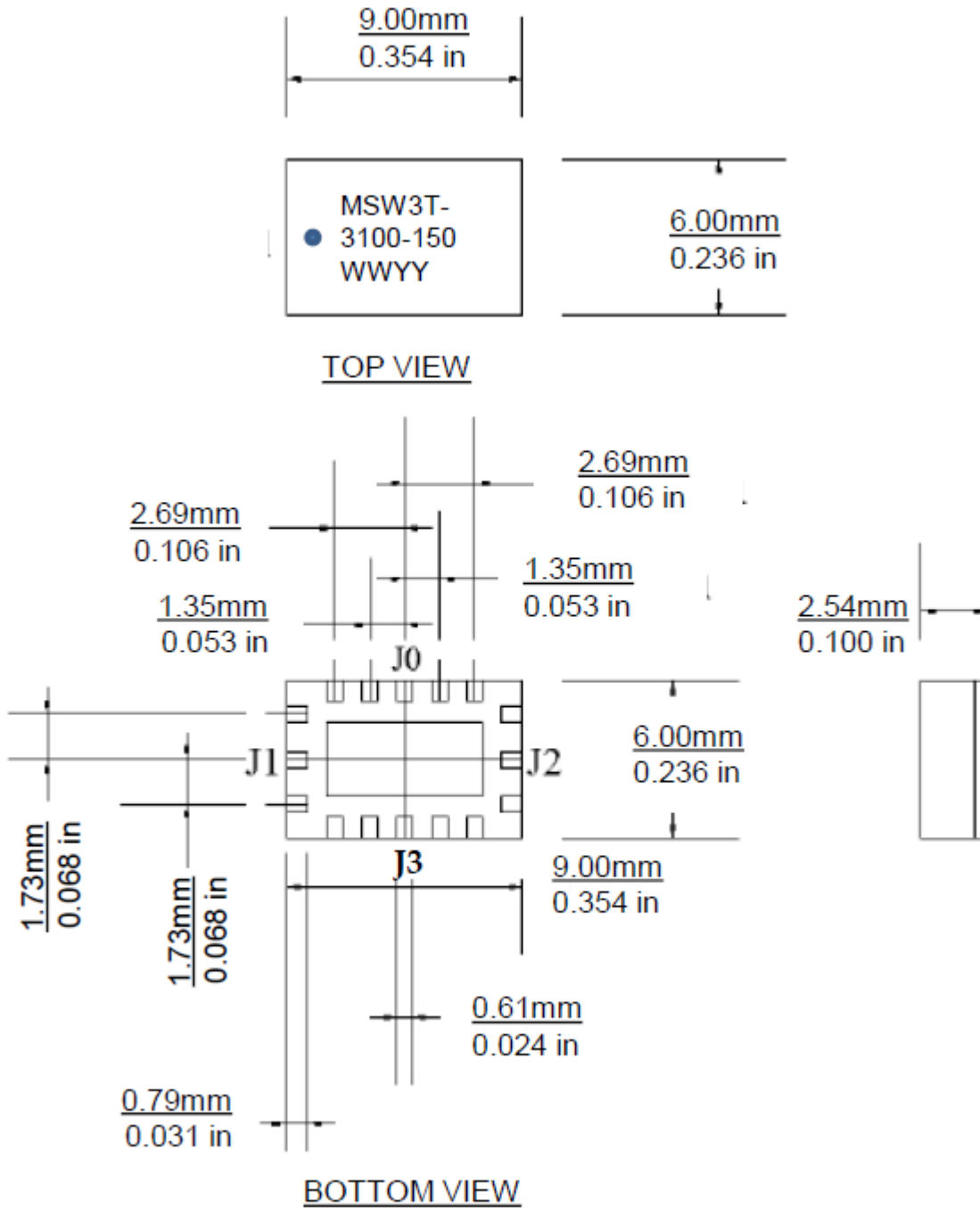

Note: Metalized area on backside is the RF, DC and Thermal ground. In user's end application this surface temperature must be managed to meet the power handling requirements.

Thermal Design Considerations:

The design of the MSW3T-310X-150 family of High Power Switches permits the maximum efficiency in thermal management of the PIN Diodes while maintaining extremely high reliability. Optimum switch performance and reliability of the switch can be achieved by the maintaining the base ground surface temperature of less than 85°C.

Recommended RF Circuit Solder Footprint for the MSW3T-310X-150

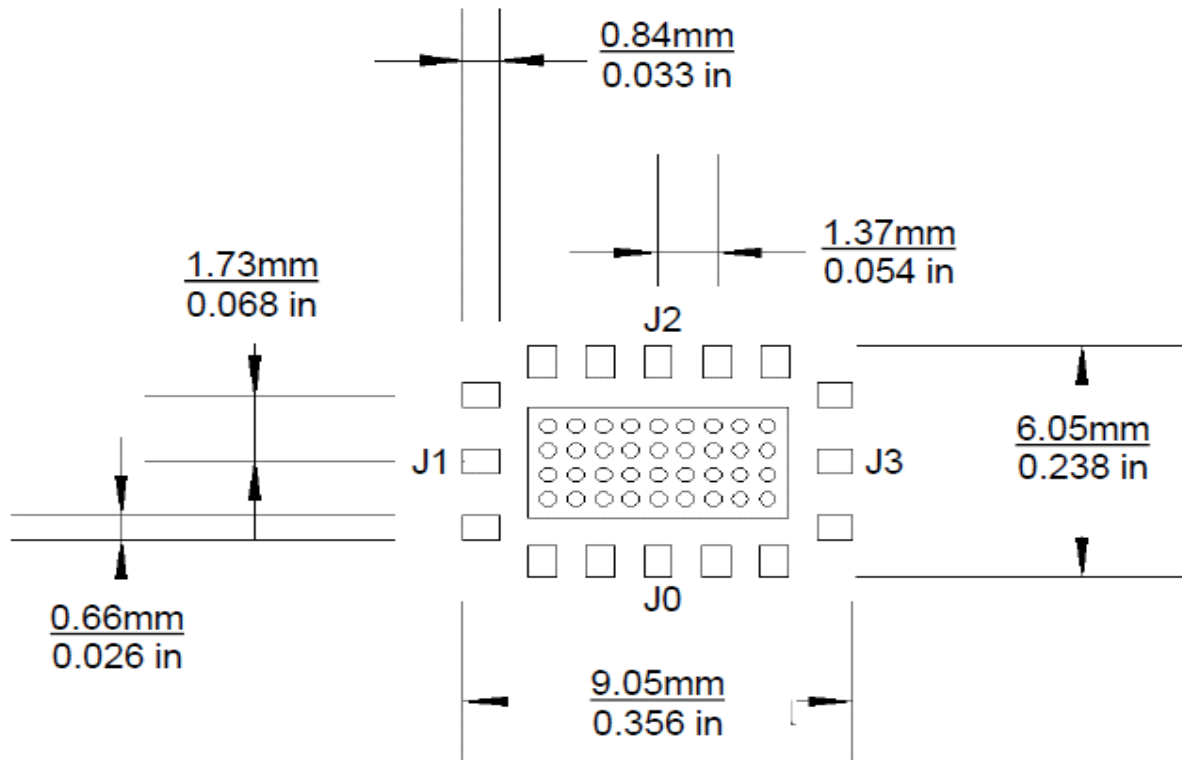

Note: The center pad is a ground plane with a matrix of 45 vias. The vias should be laid out on a 0.025" grid center-to-center. The vias should be drilled as 0.015" holes and then plated solid copper for optimal heat transfer. The device's rated power handling can only be achieved by properly heat sinking the RF switch to an external heat sink which should be located immediately beneath solder footprint thereby establishing a minimal thermal resistance to the heat sink. For further clarification, please contact Application Support.

Part Number Ordering Details:

Part Number	Packaging
MSW3T-3100-150	Gel Pak
MSW3T-3100-150TR	Tape & Reel (250 pcs)
MSW3T-3101-150	Gel Pak
MSW3T-3101-150TR	Tape & Reel (250 pcs)