



MSW6T-6000-600

SP6T High Power Series Common Cathode Switch Module

Features:

- Frequency Range: 30 MHz to 512 MHz
- High Peak Power Handling: +57 dBm
- High Average Power Handling: +53 dBm
- Low Insertion Loss: 0.1 – 0.5 dB
- Return Loss: > 15 dB
- Isolation: > 25 dB
- Surface Mount SP6T Switch Module: 8mm x 8mm x 2.5mm
- RoHS Compliant

Description:

The MSW6T-6000-600 SP6T surface mount High Power silicon PIN Diode switch is a Common Cathode configuration which was designed for transmit/receive functions and switched filter bank applications operating in the 30 MHz to 512 MHz frequency range. The MSW6T-6000-600 high power switch leverages proven high reliability hybrid manufacturing processes which yield both superior RF and thermal characteristics performance when compared to MMIC, Glass Carrier based technologies or discrete MELF packaged PIN diode designs. The hybrid design approach permits precise PIN Diode selection to optimize RF performance, superior thermal characteristics while maintaining competitive cost targets. The small form factors (8mm x 8mm x 2.5mm) offer world class power handling, low insertion loss, and superior isolation performance in a single device. The MSW6T-6000-600 symmetrical switch is tailored to minimize Transmit to Antenna loss while maximizing Transmit to Receive isolation. The MSW6T-6000-600 reliably handles up to +53 dBm CW power and up to +57 dBm peak RF incident power while operating at the $T_{\text{baseplate}} (\text{MAX}) = +55^{\circ}\text{C}$. The MSW6T-6000-600 reliably handles up to +52 dBm CW power at the $T_{\text{baseplate}} (\text{MAX}) = +85^{\circ}\text{C}$.

ESD and Moisture Sensitivity Rating

The MSW6T-6000-600 Switch Module carries a Class 1 ESD rating (HBM) and an MSL 1 moisture rating.

Thermal Management Features

A proprietary design methodology minimizes thermal resistance from the PIN Diode junction to base plate ($R_{\text{THJ-A}}$) to the customer's substrate and associated heat sink. This circuit topology coupled with the thermal characteristic of the substrate design enables reliably handling High Input RF Power up to 52 dBm CW and RF Peak Power levels up to 57 dBm with the base plate temperature at +85°C. The MSW6T-6000-600 has been

design to offer superior long term reliability in the customer’s application by utilizing ultra-thin Au plating to combat Au embrittlement concerns.

MSW6T-6000-600 Series SP6T Common Cathode Switch Module Schematic

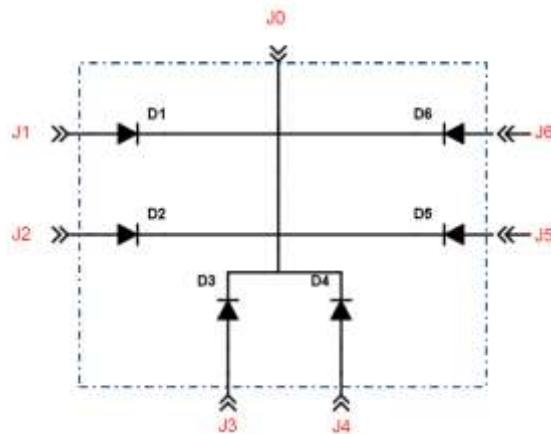

Absolute Maximum Ratings (@ $Z_0=50\Omega$, $T_A= +25^\circ\text{C}$)

Parameter	Conditions	Absolute Maximum Value
Forward Current – ON ARM		300 mA
Reverse Voltage – OFF ARMS		600 V
Forward Diode Voltage	$I_F = 100 \text{ mA}$	1.2 V
Operating Temperature		-65°C to 125°C
Storage Temperature		-65°C to +125°C
Junction Temperature		+175°C
Assembly Temperature	$T = 10 \text{ sec}$	+260°C for 10 sec
CW Incident Power	Source VSWR: 1.2:1, Load VSWR: 1.22:1, $T_{CASE} = +55^\circ\text{C}$, Cold Switching	+53 dBm
CW Incident Power	Source VSWR: 1.2:1, Load VSWR: 1.2:1, $T_{CASE} = +85^\circ\text{C}$, Cold Switching	+52 dBm
Peak Incident Power Handling	Source VSWR: 1.2:1, Load VSWR: 1.2:1, $PW = 135 \text{ usec}$, $DC = 20 \%$, $T_{case} = +55^\circ\text{C}$	+57 dBm
Peak Incident Power Handling	Source VSWR: 1.2:1, Load VSWR: 1.2:1, $PW = 80 \text{ usec}$, $DC = 20 \%$, $T_{case} = +55^\circ\text{C}$	+59 dBm

T_{CASE} is defined as the temperature of the bottom ground surface of the device.

MSW6T-6000-600 Electrical Specifications

@ $Z_0=50\Omega$, $T_A=+25^\circ\text{C}$

Parameter	Symbol	Test Condition	Min Value	Typ Value	Max Value	Units
Frequency	F		30		512	MHz
Insertion Loss	IL	ON ARM: $I_F = 100\text{ mA}$ OFF ARMS: $V_R = -50\text{V @ } 0\text{ mA}$ $P_{IN} = -10\text{ dBm}$				
		30 MHz – 250 MHz (*)		0.1	0.2	dB
		250 MHz – 400 MHz (*)		0.3	0.4	dB
		400 MHz – 512 MHz (*)		0.4	0.5	dB
Return Loss	RL	$P_{IN} = -10\text{ dBm}$ ON ARM: $I_F = 100\text{ mA}$ OFF ARMS: $V_R = -50\text{V @ } 0\text{ mA}$				dB
		30 MHz – 300 MHz (*)	15	20		dB
		300 MHz – 512 MHz (*)	11	13		dB
Isolation	ISO	$P_{IN} = -10\text{ dBm}$ ON ARM: $I_F = 100\text{ mA}$ OFF ARMS: $V_R = -50\text{V @ } 0\text{ mA}$				
		30 MHz – 300 MHz (*)	28	35		dB
		300 MHz – 512 MHz (*)	25	27		dB
CW Incident Power (Note 1)	$P_{inc}\text{ (CW)}$	ON ARM: $I_F = 100\text{ mA}$ OFF ARMS: $V_R = -200\text{V @ } 0\text{ mA}$ 1.2:1 Source VSWR & 1.2:1 Load VSWR $T_{CASE} = +55^\circ\text{C}$		52	53	dBm
Peak Incident Power (Note 1)	$P_{inc}\text{ (Peak)}$	ON ARM: $I_F = 300\text{ mA}$ OFF ARMS: $V_R = -600\text{V @ } 0\text{ mA}$ 1.2:1 Source VSWR & 1.2:1 Load VSWR, PW = 50 usec, Duty Cycle = 20%, $T_{CASE} = +55^\circ\text{C}$		57		dBm
Switching Time (Note 2)	t_{sw}	50% TTL to to 90% RF Voltage		1.5	3	usec

Conditions:

(*) These specifications can be fine tuned with external bias components.

1. The PIN Diode minimum reverse DC Voltage (VHIGH) is used to maintain the High Resistance state in the OFF PIN Diode. It is determined by the RF frequency, incident power, pulse width, duty cycle, characteristic impedance and VSWR in addition to the RF characteristics of the PIN Diodes.
2. Switching time defined to be from 50% TTL signal to 10/90% RF Voltage. This is controlled by the PIN Diode Driver circuit performance as well as the RF characteristics of the PIN Diodes.

MSW6T-6000-600 Small Signal RF Characteristics

MSW6T-6000-600 Insertion Loss

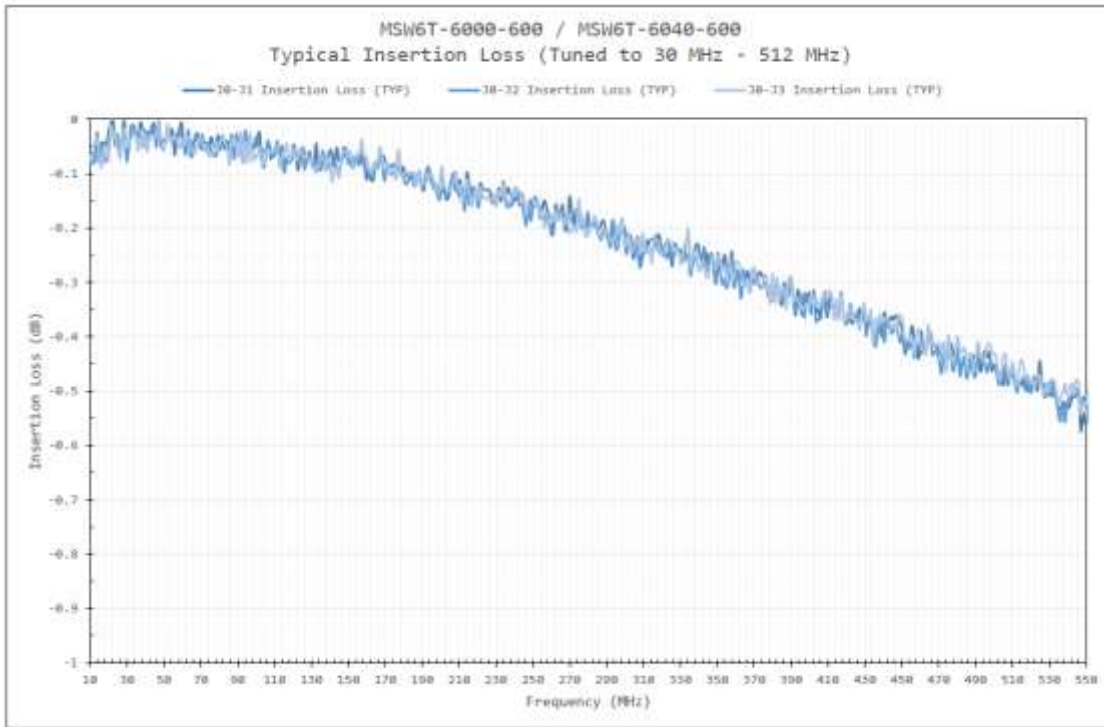

MSW6T-6000-600 Return Loss

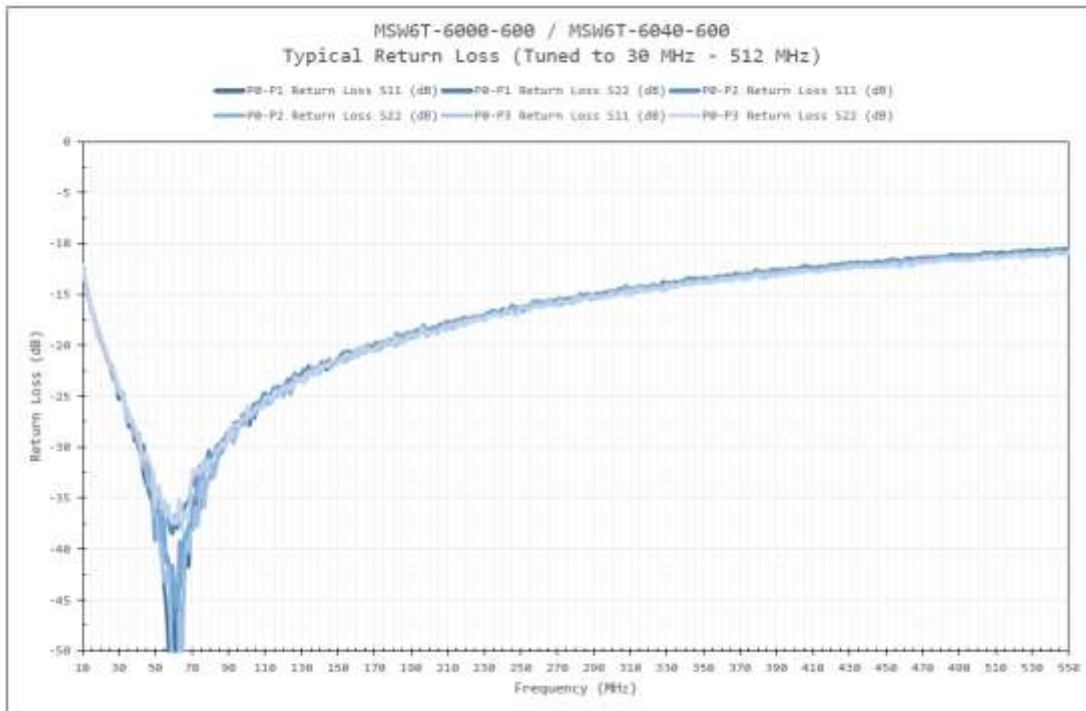

MSW6T-6000-600 Isolation

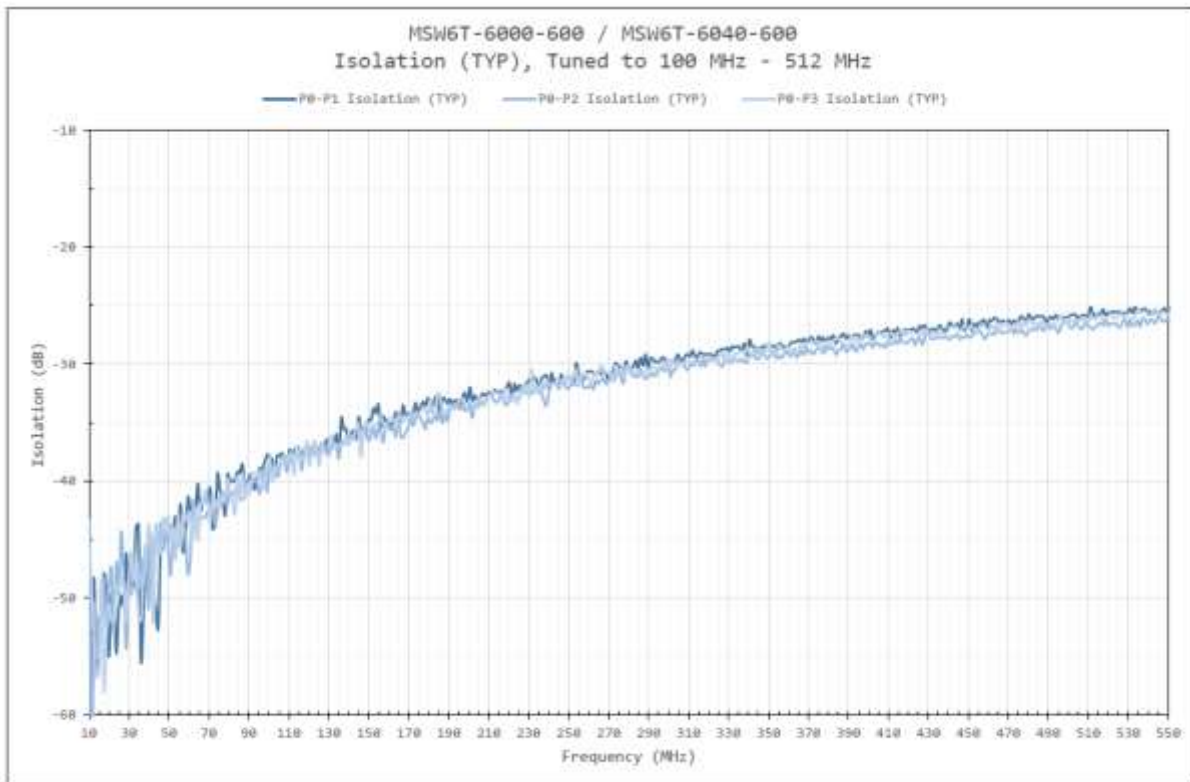

MSW6T-6000-600 Operating Truth Table:

State	J0 Bias	J1 Bias	J2 Bias	J3 Bias	J4 Bias	J5 Bias	J6 Bias
State 1 J0-J1 Low Loss J2-J6 Isolation	~0V	+5V @ +100mA	V _{MRB} @ 0 mA	V _{MRB} @ 0 mA	V _{MRB} @ 0 mA	V _{MRB} @ 0 mA	V _{MRB} @ 0 mA
State 2 J0-J2 Low Loss J1,J3-J6 Isolation	~0V	V _{MRB} @ 0 mA	+5V @ +100mA	V _{MRB} @ 0 mA	V _{MRB} @ 0 mA	V _{MRB} @ 0 mA	V _{MRB} @ 0 mA
State 3 J0-J3 Low Loss J1,J2,J4-J6 Isolation	~0V	V _{MRB} @ 0 mA	V _{MRB} @ 0 mA	+5V @ +100mA	V _{MRB} @ 0 mA	V _{MRB} @ 0 mA	V _{MRB} @ 0 mA
State 4 J0-J4 Low Loss J1-J3,J5,J6 Isolation	~0V	V _{MRB} @ 0 mA	V _{MRB} @ 0 mA	V _{MRB} @ 0 mA	+5V @ +100mA	V _{MRB} @ 0 mA	V _{MRB} @ 0 mA
State 5 J0-J5 Low Loss J1-J4, J6 Isolation	~0V	V _{MRB} @ 0 mA	V _{MRB} @ 0 mA	V _{MRB} @ 0 mA	V _{MRB} @ 0 mA	+5V @ +100mA	V _{MRB} @ 0 mA
State 6 J0-J6 Low Loss J1-J5 Isolation	~0V	V _{MRB} @ 0 mA	V _{MRB} @ 0 mA	V _{MRB} @ 0 mA	V _{MRB} @ 0 mA	V _{MRB} @ 0 mA	+5V @ +100mA

Note: 1) V_{MRB} value please refer to the Minimum Reverse Bias Voltage vs Frequency table to determine the required biasing voltage as various frequencies and power levels.

Minimum Reverse Bias Voltage vs Frequency

Frequency	30 MHz	88 MHz	225 MHz	512 MHz
Reverse Bias Voltage	-200V	-185V	-150V	-100V

Note: Signal conditions:

Input Power: 100W (CW)
 Source VSWR: 1.2 : 1
 Load VSWR: 1.2 : 1

Assembly Instructions

The MSW6T-6000-600 may be attached to the printed circuit card using solder reflow procedures using either RoHS or Sn63/ Pb37 type solders per the Table and Temperature Profile Graph shown below:

Profile Parameter	Sn-Pb Assembly Technique	RoHS Assembly Technique
Average ramp-up rate (T_L to T_P)	3°C/sec (max)	3°C/sec (max)
Preheat		
Temp Min (T_{smin})	100°C	100°C
Temp Max (T_{smax})	150°C	150°C
Time (min to max) (t_s)	60 – 120 sec	60 – 180 sec
T_{smax} to T_L		
Ramp up Rate		3°C/sec (max)
Peak Temp (T_P)	225°C +0°C / -5°C	260°C +0°C / -5°C
Time within 5°C of Actual Peak Temp (T_P)	10 to 30 sec	20 to 40 sec
Time Maintained Above:		
Temp (T_L)	183°C	217°C
Time (t_L)	60 to 150 sec	60 to 150 sec
Ramp Down Rate	6°C/sec (max)	6°C/sec (max)
Time 25°C to T_P	6 minutes (max)	8 minutes (max)

Solder Re-Flow Time-Temperature Profile

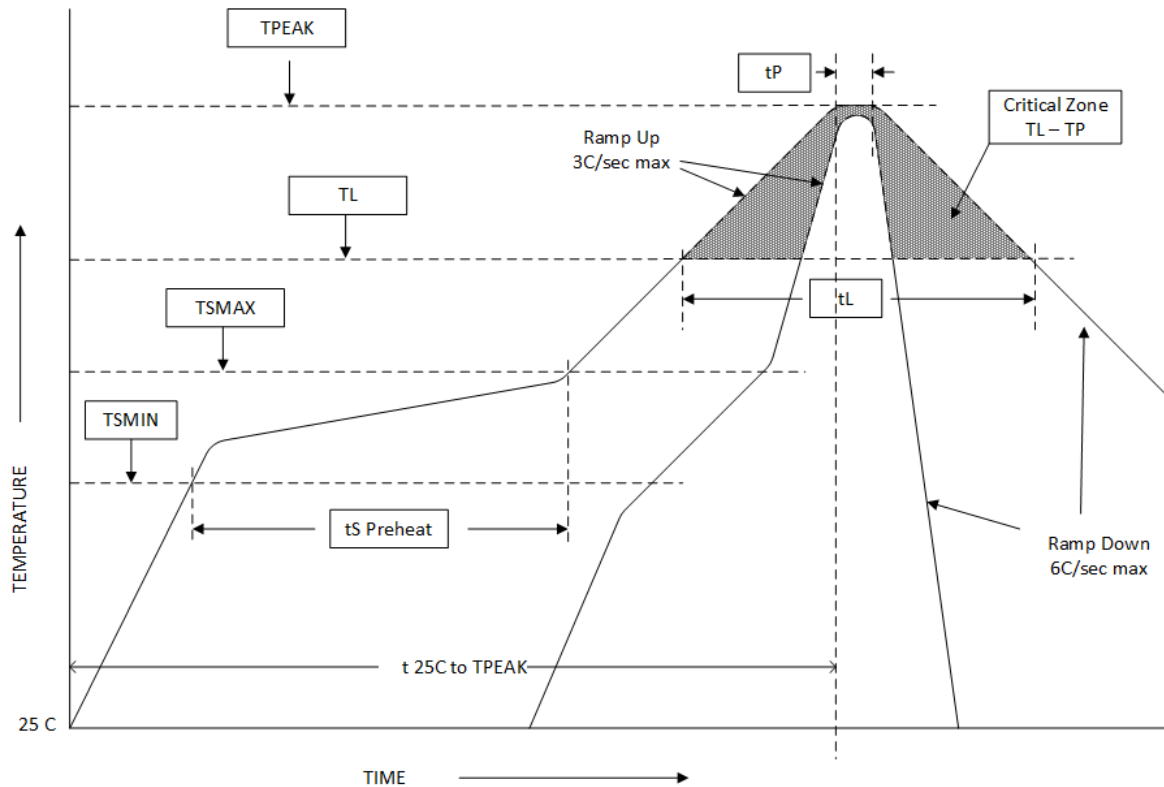

MSW6T-6000-600 Switch Module Package Outline Drawing

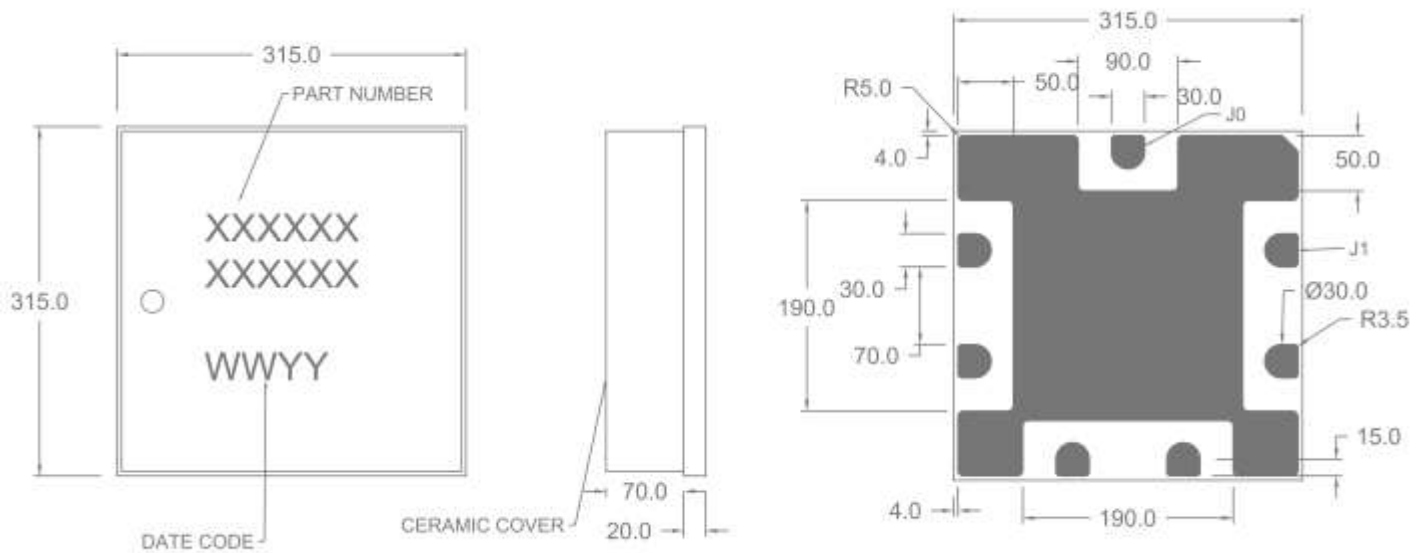
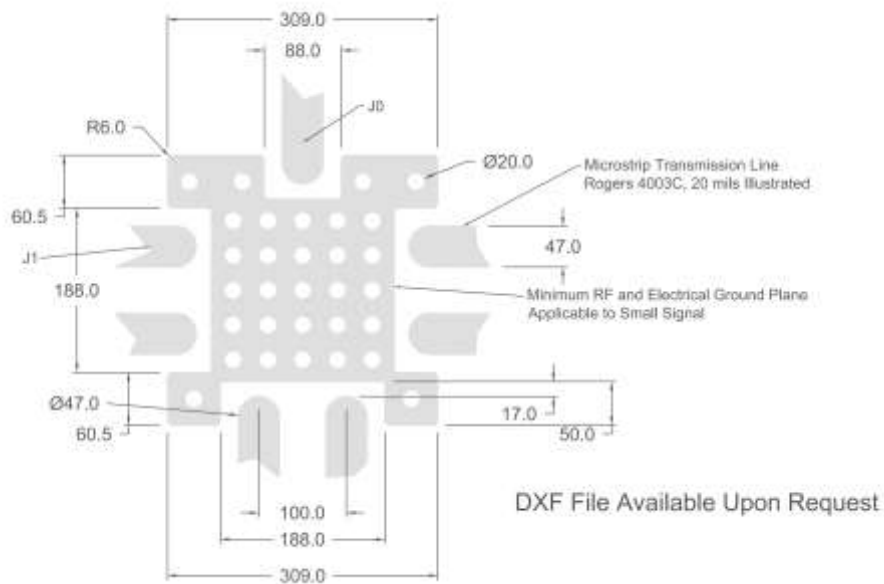

Figure 1 Module Outline and Markings; Units in mils

Notes:

- 1) Metalized area on backside is the RF, DC and Thermal ground. In user's end application this surface temperature must be managed to meet the power handling requirements (Tcase).
- 2) RF Cover: White Ceramic
- 3) Substrate Material: 20 mils Aluminum Nitride (AlN)

MSW6T-6000-600 Suggested Footprint (Unit in mils)



Thermal Design Considerations:

The design of the MSW6T-6000-600 permits the maximum efficiency in thermal management of the PIN Diodes while maintaining extremely high reliability. Optimum switch performance and reliability of the device can be achieved by the maintaining the base ground surface temperature of less than +85°C.

There must be a minimal thermal and electrical resistance between the bottom surface of the switch package and ground/heat sink system. Adequate thermal management is required to maintain a T_{JC} at less than +175°C and thereby avoid adversely affecting the semiconductor reliability. Special care must be taken to assure that minimal voiding occurs in the solder connection in the area shaded in red in the figure shown below:

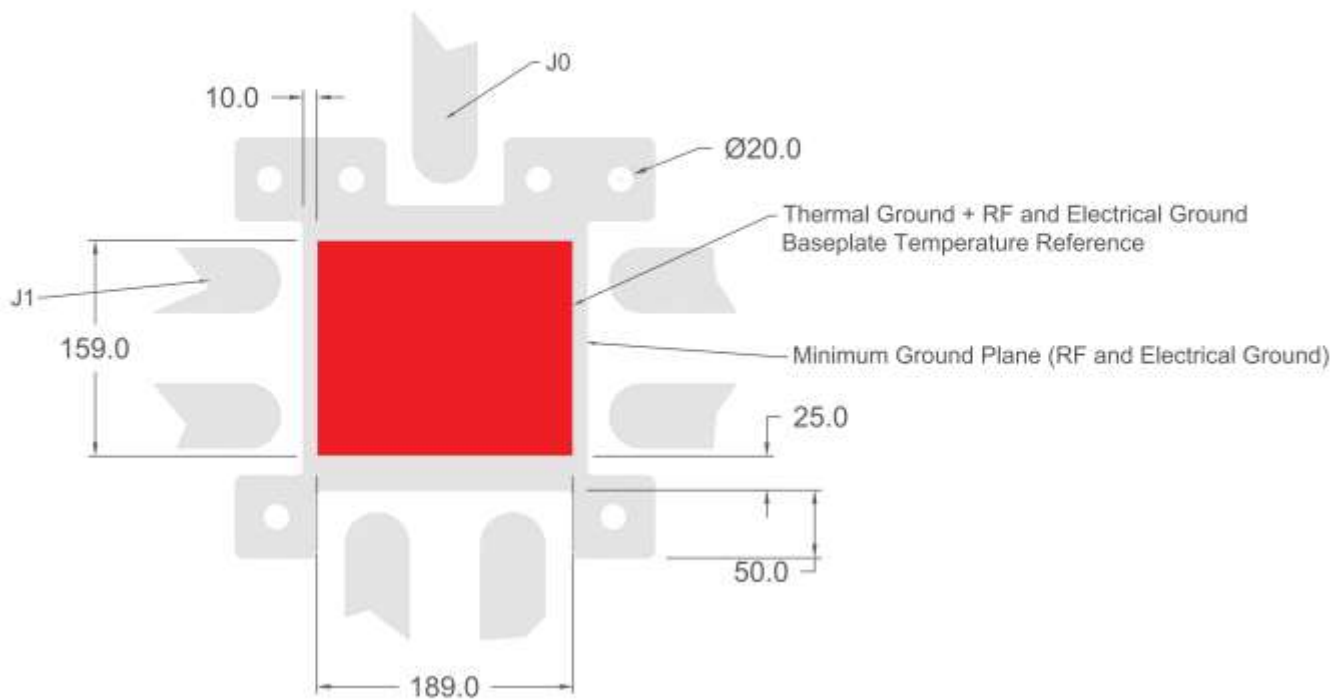

MSW6T-6000-600 Biasing Schematic

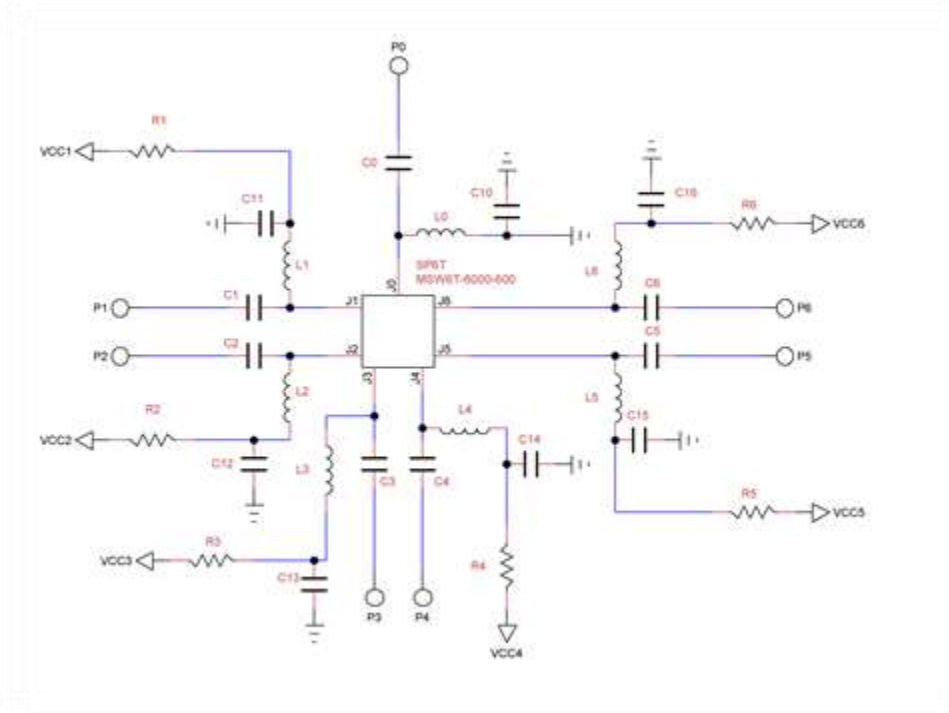

Component	Label	MFG PN
RF Inductor	L0 – L6	1008LS-222XJE Coilcraft, 2.2 UH
RF Coupling Capacitor	C0, C1, C2, C3, C4, C5, C6	TDK, 06032C102JAT2A, 200V, 1000 PF, X7R, 0603 (*) (*) Usage is two; total capacitance is ~ 2000 pF
RF Bypass Capacitor	C10, C11, C12, C13, C14, C15, C16	AVX, 08052C182KAT2A, 200V, 1800 PF, X7R, 0805 (X1)
Current Limit Resistor	R1, R2, R3, R4, R5, R6	150 mA ≤ Forward Bias Current ≤ 250 mA; RF Power, Frequency and Linearity Dependant

Part Number Ordering Detail:

The MSW6T-6000-600 Switch Modules is available in the following format:

Part Number	Description	Packaging
MSW6T-6000-600	SP6T 30 MHz – 512 MHz 8mm x 8mm	Gel Pack
MSW6T-6000-600 HP EVB	MSW6T-6000-600 High Power Eval Board	Box